

# 650V, 7.0A, 350mΩ N-channel Power SuperJunction MOSFET

## JMH65R400MKFD

### Features

- Excellent  $R_{DS(ON)}$  and Low Gate Charge
- 100% UIS Tested
- 100%  $\Delta V_{ds}$  Tested
- Halogen-free; RoHS-compliant

### Applications

- SMPS with PFC
- Flyback and LLC topologies
- Silver ATX, adapter, TV, lighting, Telecom

### Product Summary

Parameters	Value	Unit
$V_{DSS}$	650	V
$V_{GS(th\_Typ)}$	4.0	V
$I_D(@V_{GS}=10V)$	7.0	A
$R_{DS(ON)\_Typ}(@V_{GS}=10V)$	350	mΩ

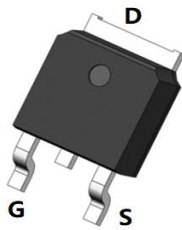

TO-252-3L

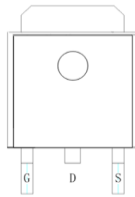

Pin Assignment

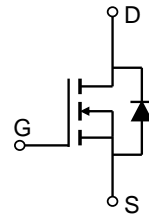

Schematic Diagram

### Ordering Information

Device	Marking	MSL	Form	Package	Reel(pcs)	Per Carton (pcs)
JMH65R400MKFD-13	H65R400MF	3	Tape&Reel	TO-252-3L	2500	25000

### Absolute Maximum Ratings (@ $T_C = 25^\circ\text{C}$ unless otherwise specified)

Symbol	Parameter	Value	Unit
$V_{DS}$	Drain-to-Source Voltage	650	V
$V_{GS}$	Gate-to-Source Voltage	$\pm 30$	V
$I_D$	Continuous Drain Current	$T_C = 25^\circ\text{C}$	7.0
		$T_C = 100^\circ\text{C}$	4.4
$I_{DM}$	Pulsed Drain Current <sup>(1)</sup>	Refer to Fig.4	A
$E_{AS}$	Single Pulsed Avalanche Energy <sup>(2)</sup>	29	mJ
$P_D$	Power Dissipation	$T_C = 25^\circ\text{C}$	50
		$T_C = 100^\circ\text{C}$	20
$T_J, T_{STG}$	Junction & Storage Temperature Range	-55 to 150	$^\circ\text{C}$

### Thermal Characteristics

Symbol	Parameter	Max	Unit
$R_{\theta JA}$	Thermal Resistance, Junction to Ambient <sup>(3)</sup>	39	$^\circ\text{C}/\text{W}$
$R_{\theta JC}$	Thermal Resistance, Junction to Case	2.5	

**Electrical Characteristics** ( $T_J = 25^\circ\text{C}$  unless otherwise specified)

Symbol	Parameter	Conditions	Min.	Typ.	Max.	Unit
<b>Off Characteristics</b>						
$V_{(BR)DSS}$	Drain-Source Breakdown Voltage	$I_D = 250\mu\text{A}$ , $V_{GS} = 0\text{V}$	650	-	-	V
$I_{DSS}$	Zero Gate Voltage Drain Current	$V_{DS} = 650\text{V}$ , $V_{GS} = 0\text{V}$	-	-	1.0	$\mu\text{A}$
$I_{GSS}$	Gate-Body Leakage Current	$V_{DS} = 0\text{V}$ , $V_{GS} = \pm 30\text{V}$	-	-	$\pm 100$	nA
<b>On Characteristics</b>						
$V_{GS(th)}$	Gate Threshold Voltage	$V_{DS} = V_{GS}$ , $I_D = 250\mu\text{A}$	3.0	4.0	5.0	V
$R_{DS(ON)}$	Static Drain-Source ON-Resistance <sup>(4)</sup>	$V_{GS} = 10\text{V}$ , $I_D = 5.5\text{A}$	-	350	400	m $\Omega$
<b>Dynamic Characteristics</b>						
$R_g$	Gate Resistance	$f = 1\text{MHz}$	-	17	-	$\Omega$
$C_{iss}$	Input Capacitance	$V_{GS} = 0\text{V}$ , $V_{DS} = 325\text{V}$ , $f = 1\text{MHz}$	608	851	1149	pF
$C_{oss}$	Output Capacitance		20	29	39	pF
$C_{rss}$	Reverse Transfer Capacitance		-	4.8	-	pF
$Q_g$	Total Gate Charge	$V_{GS} = 0$ to $10\text{V}$ $V_{DS} = 325\text{V}$ , $I_D = 5.5\text{A}$	14	19	26	nC
$Q_{gs}$	Gate Source Charge		-	6	-	nC
$Q_{gd}$	Gate Drain ("Miller") Charge		-	6.7	-	nC
<b>Switching Characteristics</b>						
$t_{d(on)}$	Turn-On Delay Time	$V_{GS} = 10\text{V}$ , $V_{DD} = 325\text{V}$ $I_D = 5.5\text{A}$ , $R_{GEN} = 24\Omega$	-	30	-	ns
$t_r$	Turn-On Rise Time		-	33	-	ns
$t_{d(off)}$	Turn-Off Delay Time		-	84	-	ns
$t_f$	Turn-Off Fall Time		-	29	-	ns
<b>Body Diode Characteristics</b>						
$I_S$	Maximum Continuous Body Diode Forward Current		-	-	7	A
$I_{SM}$	Maximum Pulsed Body Diode Forward Current		-	-	28	A
$V_{SD}$	Body Diode Forward Voltage	$V_{GS} = 0\text{V}$ , $I_S = 5.5\text{A}$	-	-	1.2	V
$t_{rr}$	Body Diode Reverse Recovery Time	$I_F = 5.5\text{A}$ , $di/dt = 100\text{A}/\mu\text{s}$	70	98	132	ns
$Q_{rr}$	Body Diode Reverse Recovery Charge		-	469	-	nC

- Notes:
1. Repetitive Rating: Pulse Width Limited by Maximum Junction Temperature.
  2.  $E_{AS}$  condition: Starting  $T_J = 25^\circ\text{C}$ ,  $V_{DD} = 75\text{V}$ ,  $V_{GS} = 10\text{V}$ ,  $R_G = 25\text{ohm}$ ,  $L = 10\text{mH}$ ,  $I_{AS} = 2.4\text{A}$ ,  $V_{DD} = 0\text{V}$  during time in avalanche.
  3.  $R_{\theta JA}$  is measured with the device mounted on a  $1\text{inch}^2$  pad of 2oz copper FR4 PCB.
  4. Pulse Test: Pulse Width  $\leq 300\mu\text{s}$ , Duty Cycle  $\leq 0.5\%$ .

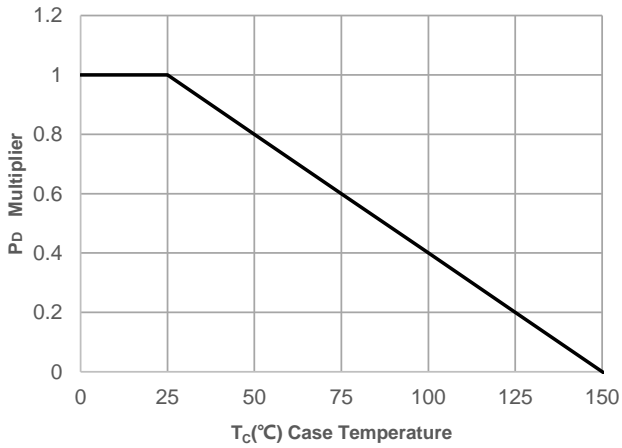
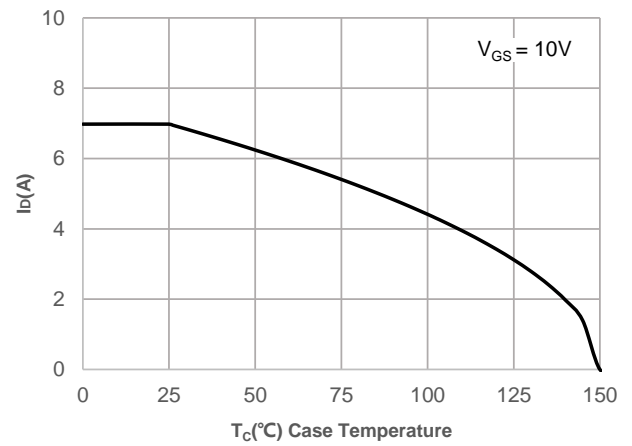
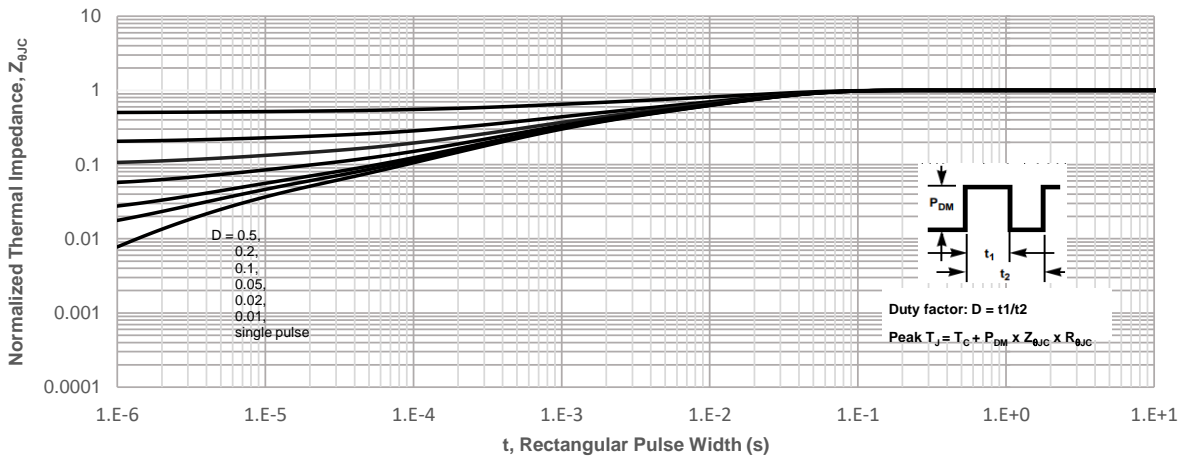
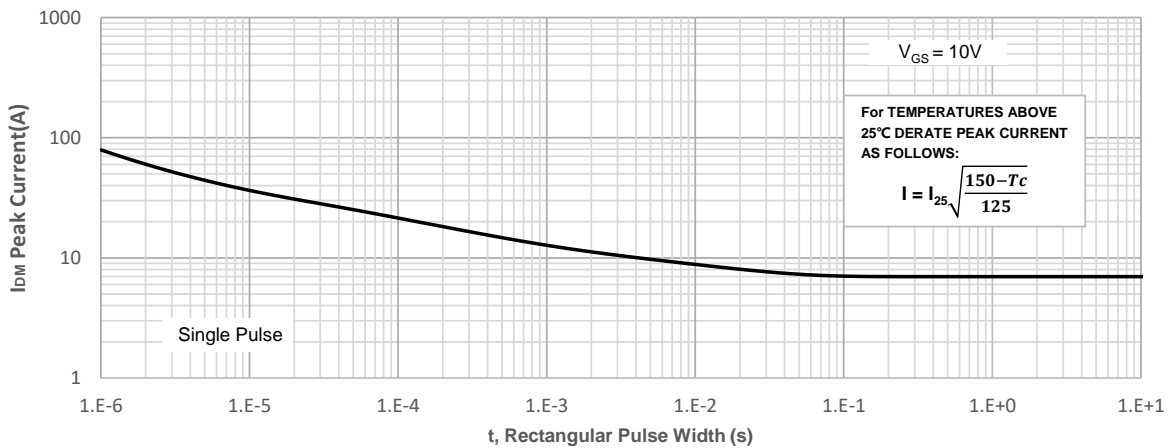

## Typical Performance Characteristics

**Figure 1: Power De-rating**

**Figure 2: Current De-rating**

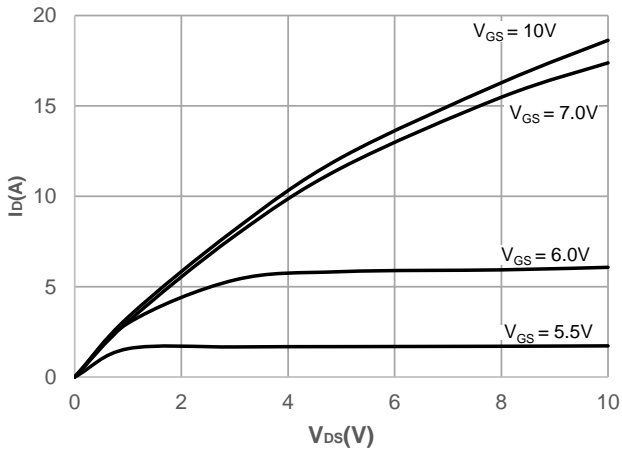
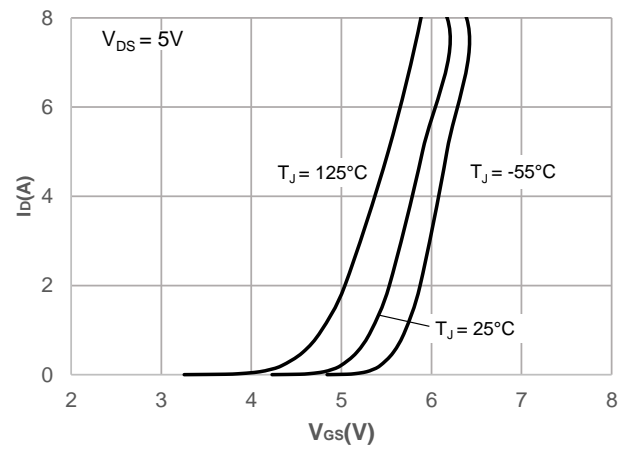
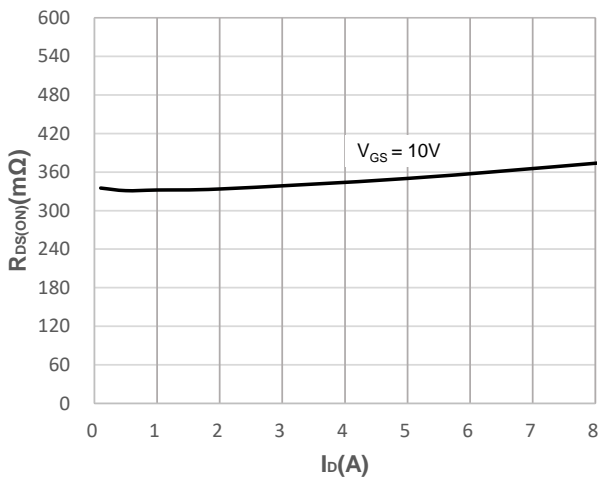
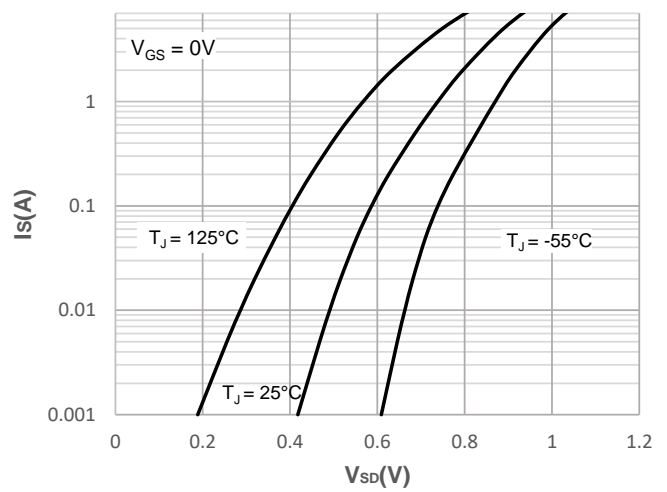
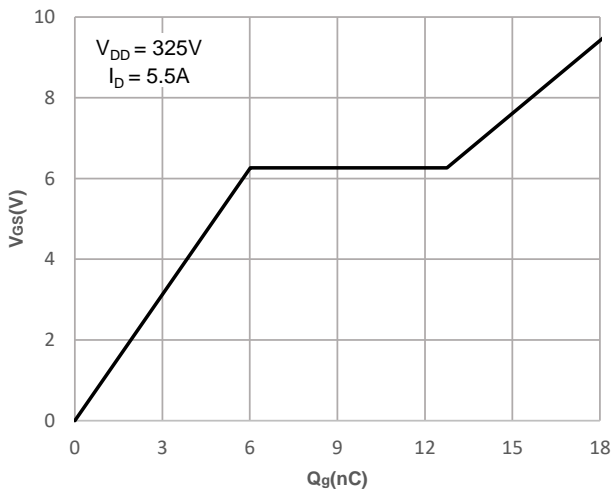
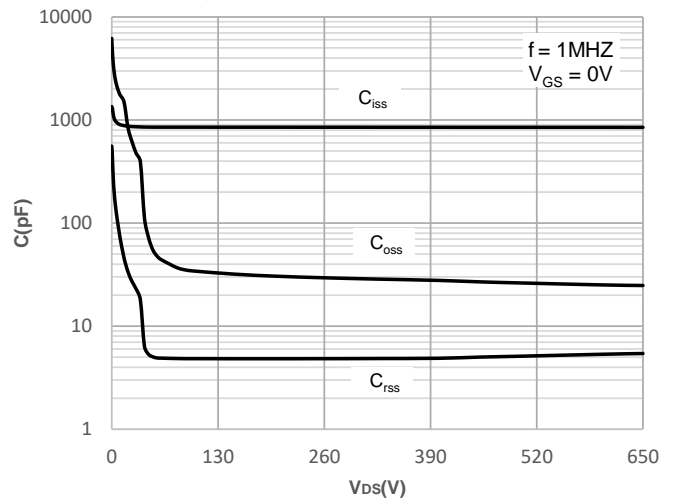
**Figure 3: Normalized Maximum Transient Thermal Impedance**

**Figure 4: Peak Current Capacity**

## Typical Performance Characteristics

**Figure 5: Output Characteristics**

**Figure 6: Typical Transfer Characteristics**

**Figure 7: On-resistance vs. Drain Current**

**Figure 8: Body Diode Characteristics**

**Figure 9: Gate Charge Characteristics**

**Figure 10: Capacitance Characteristics**

## Typical Performance Characteristics

Figure 11: Normalized Breakdown voltage vs. Junction Temperature

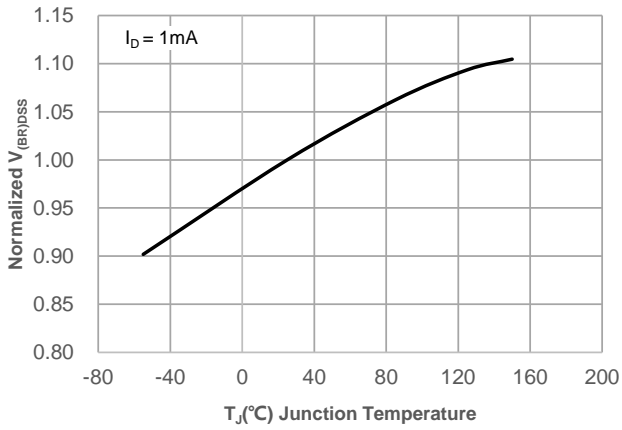

Figure 12: Normalized on Resistance vs. Junction Temperature

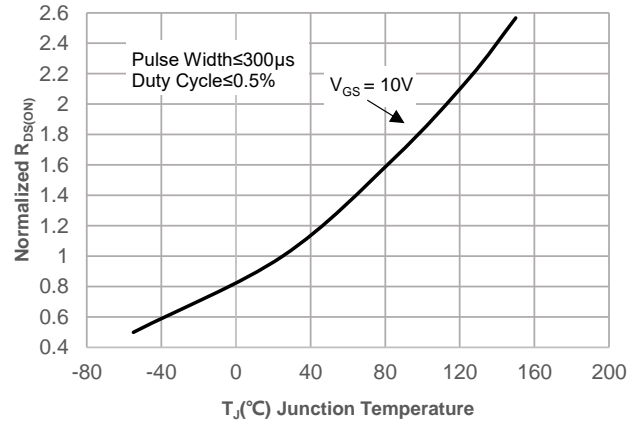

Figure 13: Normalized Threshold Voltage vs. Junction Temperature

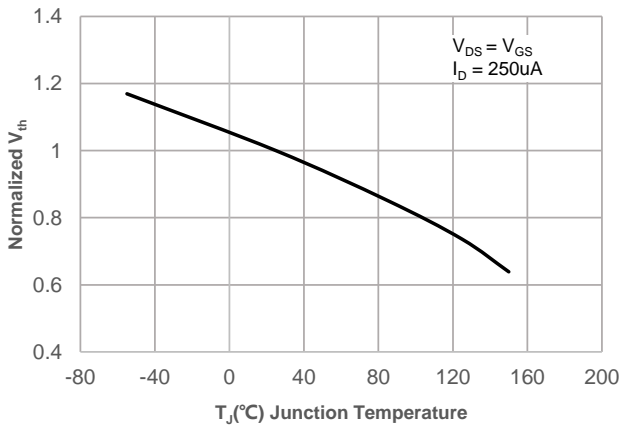

Figure 14:  $R_{DS(ON)}$  vs.  $V_{GS}$

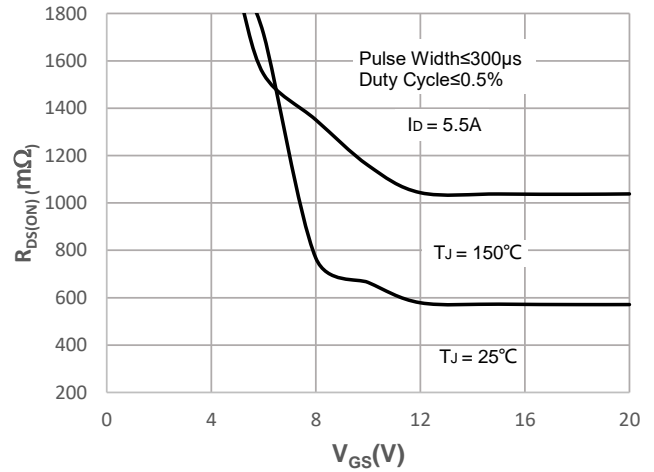
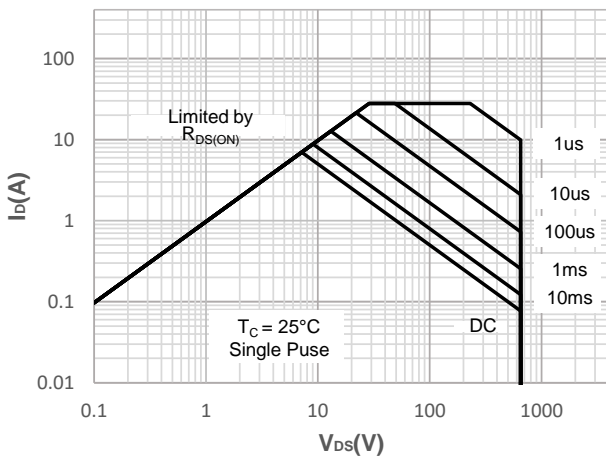
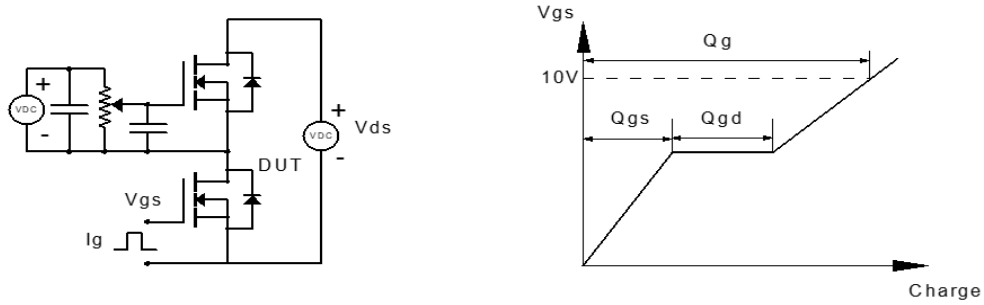

Figure 15: Maximum Safe Operating Area



**Test Circuit**

**Figure 1: Gate Charge Test Circuit & Waveform**

**Figure 2: Resistive Switching Test Circuit & Waveform**

**Figure 3: Unclamped Inductive Switching Test Circuit & Waveform**

**Figure 4: Diode Recovery Test Circuit & Waveform**

## Package Mechanical Data(TO-252-3L)

### Package Outline

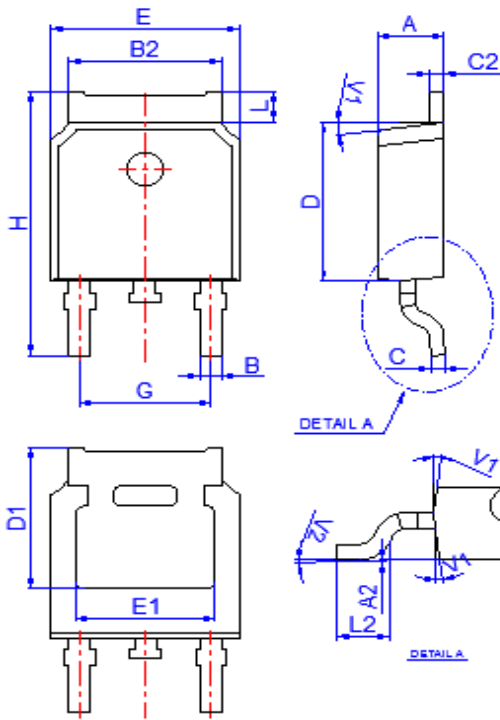

Ref.	Dimensions					
	Millimeters			Inches		
	Min.	Typ.	Max.	Min.	Typ.	Max.
A	2.10		2.50	0.083		0.098
A2	0		0.15	0		0.006
B	0.66		0.86	0.026		0.034
B2	5.18		5.48	0.202		0.216
C	0.40		0.60	0.016		0.024
C2	0.44		0.58	0.017		0.023
D	5.90		6.30	0.232		0.248
D1	5.30REF			0.209RE F		
E	6.40		6.80	0.252		0.268
E1	4.63			0.182		
G	4.47		4.67	0.176		0.184
H	9.50		10.70	0.374		0.421
L	1.09		1.21	0.043		0.048
L2	1.35		1.65	0.053		0.065
V1		7°			7°	
V2		0°	6°		0°	6°

### Recommended Soldering Footprint

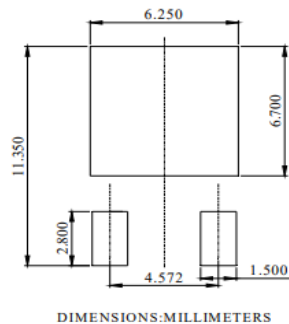

Information furnished in this document is believed to be accurate and reliable. However, Jiangsu JieJie Microelectronics Co.,Ltd assumes no responsibility for the consequences of use without consideration for such information nor use beyond it. Information mentioned in this document is subject to change without notice, apart from that when an agreement is signed, Jiangsu JieJie complies with the agreement. Products and information provided in this document have no infringement of patents. Jiangsu JieJie assumes no responsibility for any infringement of other rights of third parties which may result from the use of such products and information.

is a registered trademark of Jiangsu JieJie Microelectronics Co.,Ltd.

